

Varenummer: 203260M850A1S
 Beskrivelse: E+G Justerfod
 GN 32-60-M8-50-A1-S
 Note: S Uden møtrik, udvendig sekskant i bunden

Mål

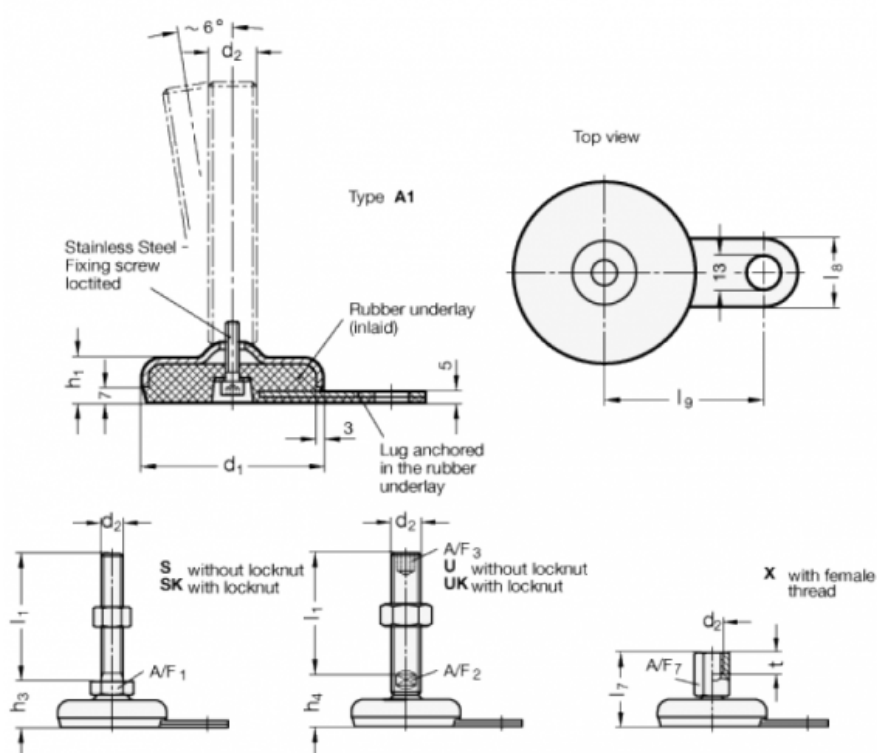

A/F1	= 17
d1	= 60
d2	= M8
h1	= 19
h3	= 27
l1	= 50
l8	= 25
l9	= 50